

04

LINEAR LIGHT

Table of Contents



04 LINEAR LIGHT

TYPE A	03
X-2	04
G5	05
G8	06
T3	07

TYPE A

Surface Mounted LED Linear Light



Surface mounted, TYPE A linear light is designed where recessed installation is not an option. These extrusion is perfect to be installed but not limited to, in any flat surfaces whether it is a ceiling or wall, under or on top of the cabinet, display cases, shelvings and art niches. Installation is simple and easy, Supplied in standard 1m or 2m lengths and cut-lengths can be customised upon request.



Installation

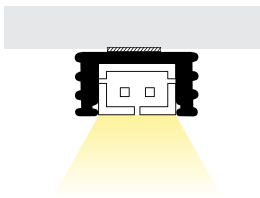

Surface Mounting



Connector

Dimension

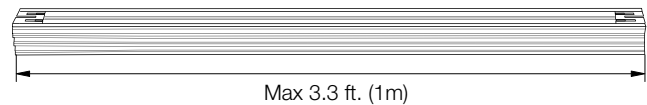
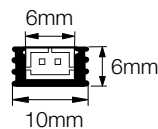

Accessories



- ① Aluminum Profile
- ② 3M Tape
- ③ 3pcs Connector

LED Color Temperature

White LED Color Temperature (Standard Color)



Specifications

Electrical	
Input Voltage	12V / 24V DC Class 2
Power Consumption	Standard : 2.2 w/ft. High - Lumn : 3 w/ft.
Brightness	2,000 Lux to 10,000 Lux
Color Temperature	White LED / R or G or B
CRI	90+

Physical	
Max Length	3.3 ft. (1m)
Weight/m	60g
Dimension (WxH)	3/8" (10mm) x 1/4" (6mm)
Diffuser	N/A
Environment	-30°C (-22°F) ~ +40°C (+104°F)
Operating Temperature	Dry location only (Indoor)
Warranty	3 Years

X-2

Corner Mounted LED Linear Light



X-2 linear light is very well designed for 90 degree corner installations. Designed to highlight corners, perfect for the joints between walls, cabinets or ceilings and allows a minimalist lighting solution. Installation is simple and easy, Supplied in standard 1m or 2m lengths and cut-lengths can be customised upon request.



Installation

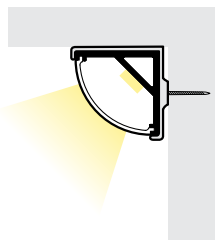

Corner Mounting

Dimension

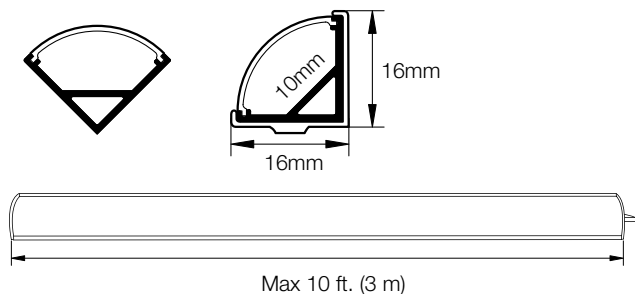

Accessories

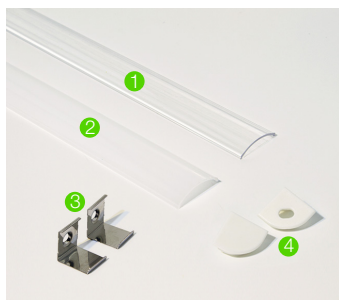

- 1 Clear Diffuser
- 2 Frosted Diffuser
- 3 Clips
- 4 Plastic End Caps

LED Color Temperature

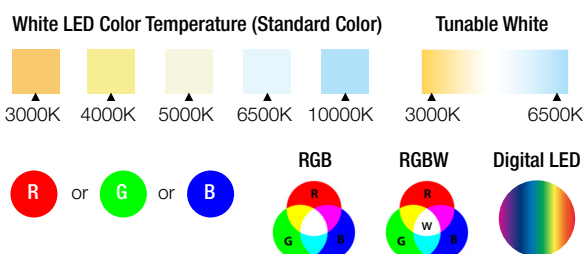

Specifications

Electrical	
Input Voltage	12V / 24V DC Class 2
Power Consumption	Standard : 2.2 w/ft. High - Lumn : 3 w/ft.
Brightness	2,000 Lux to 10,000 Lux
Color Temperature	White LED / Tunable White R or G or B / RGB / RGBW / Digital LED
CRI	90+

Physical	
Max Length	10 ft. (3m)
Weight/m	210g
Dimension (WxH)	5/8" (16mm) x 5/8" (16mm)
Diffuser	Clear / Frosted
Environment	-30°C (-22°F) ~ +40°C (+104°F)
Operating Temperature	Dry location only (Indoor)
Warranty	3 Years

G5

Surface Mounted LED Linear Light



Surface mounted, G5 linear light is perfect for where recessed lighting is not an option. The LED strip lights with extrusion housing can help set the mood of each room in homes, offices and retail stores, creating a particular modern flare. Supplied in standard 1m or 2m lengths and cut-lengths can be customised upon request.

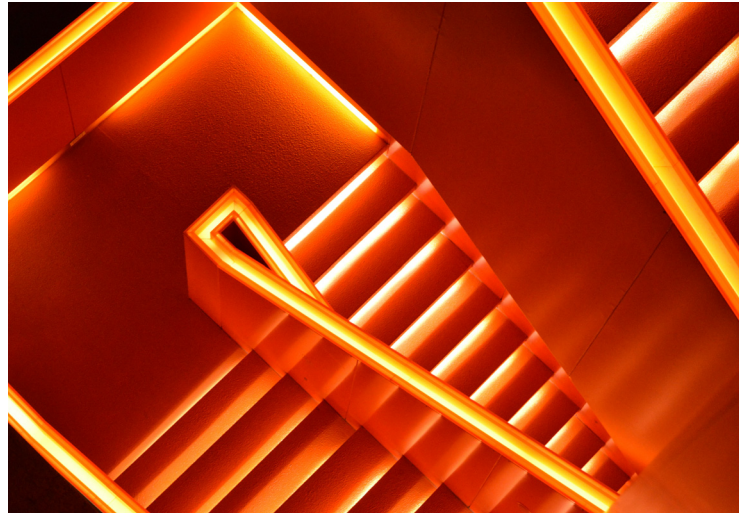

Installation

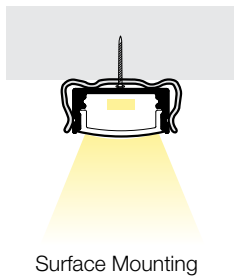

Dimension

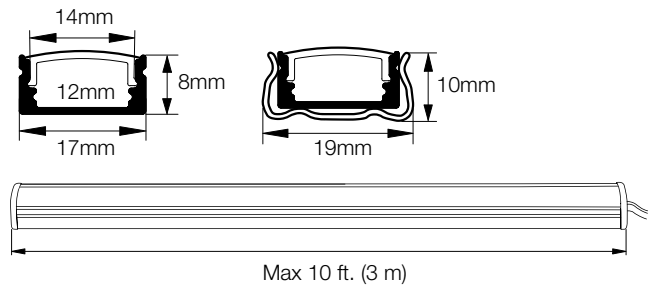

Accessories

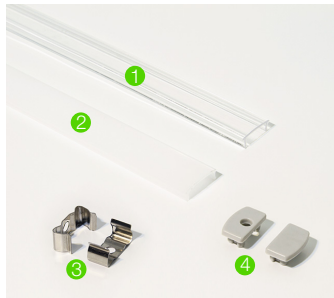

- 1 Clear Diffuser
- 2 Frosted Diffuser
- 3 Clips
- 4 Plastic End Caps

LED Color Temperature

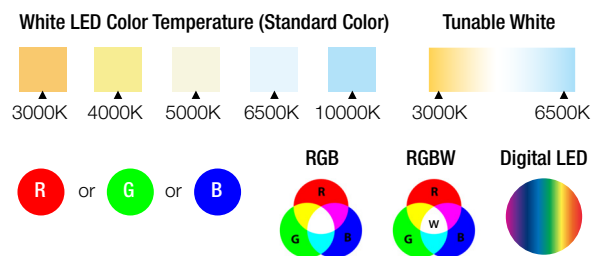

Specifications

Electrical	
Input Voltage	12V / 24V DC Class 2
Power Consumption	Standard : 2.2 w/ft. High - Lumn : 3 w/ft.
Brightness	2,000 Lux to 10,000 Lux
Color Temperature	White LED / Tunable White R or G or B / RGB / RGBW / Digital LED
CRI	90+

Physical	
Max Length	10 ft. (3m)
Weight/m	100g
Dimension (WxH)	1 1/16" (17mm) x 5/16" (8mm)
Diffuser	Clear / Frosted
Environment	-30°C (-22°F) ~ +40°C (+104°F)
Operating Temperature	Dry location only (Indoor)
Warranty	3 Years

G8

Surface Mounted LED Linear Light



Surface mounted, G8 linear light is perfect for where recessed lighting is not an option. It comes with a square diffuser for soft direct and indirect lighting. Supplied in standard 1m or 2m lengths. The high quality aluminium extrusion can be cut to length as your require.



Installation

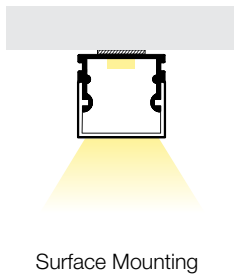

Dimension

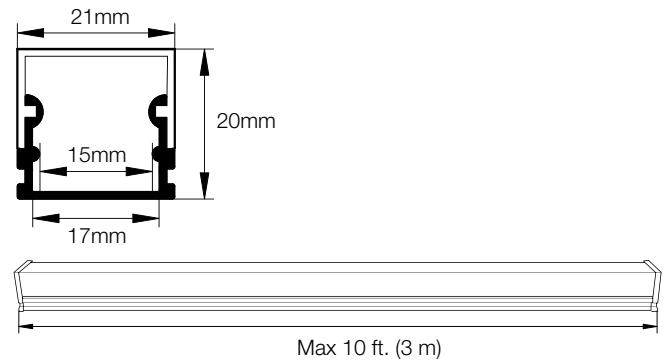

Accessories

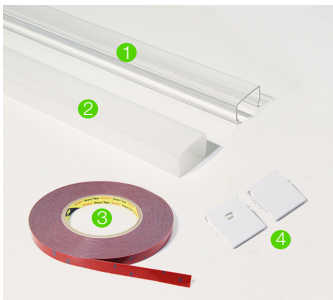

- ① Clear Diffuser
- ② Frosted Diffuser
- ③ 3M Tape
- ④ Plastic End Caps

LED Color Temperature

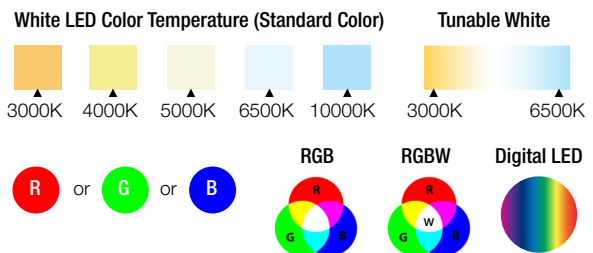

Specifications

Electrical	
Input Voltage	12V / 24V DC Class 2
Power Consumption	Standard : 2.2 w/ft. High - Lumn : 3 w/ft.
Brightness	2,000 Lux to 10,000 Lux
Color Temperature	White LED / Tunable White R or G or B / RGB / RGBW / Digital LED
CRI	90+

Physical	
Max Length	10 ft. (3m)
Weight/m	210g
Dimension (WxH)	13/16" (21mm) x 25/32" (20mm)
Diffuser	Clear / Frosted
Environment	-30°C (-22°F) ~ +40°C (+104°F)
Operating Temperature	Dry location only (Indoor)
Warranty	3 Years

T3

Recessed Mounted LED Linear Light



T3 linear light offers a wide variety of quality recessed aluminium extrusions or profiles for LED strip lights. Recessed extrusions can be installed under cabinets, shelves or furniture with the use of double-sided tape or clip. Supplied in standard 1m or 2m lengths and cut-lengths can be customised upon request.

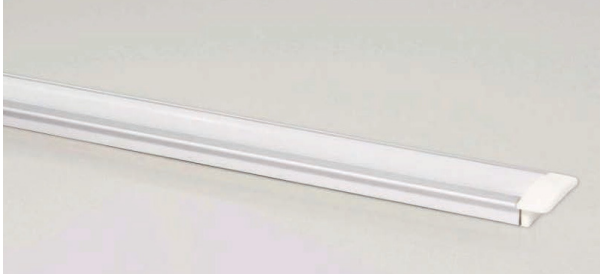

Installation

▪ Tape



▪ Clip

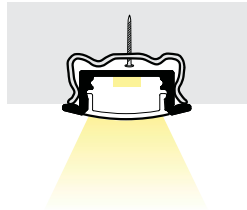

Recessed Mounting

Dimension

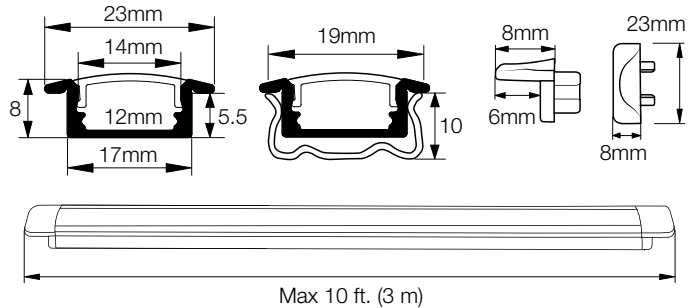

Accessories

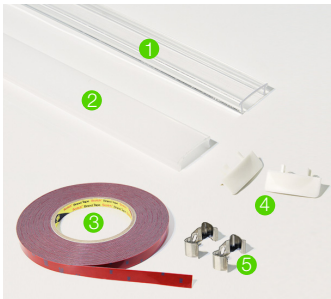

- 1 Clear Diffuser
- 2 Frosted Diffuser
- 3 3M Tape
- 4 Plastic End Caps
- 5 Clips

LED Color Temperature

White LED Color Temperature (Standard Color)

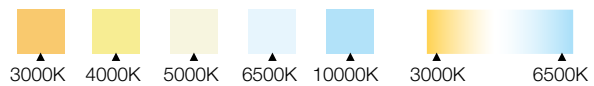

Tunable White

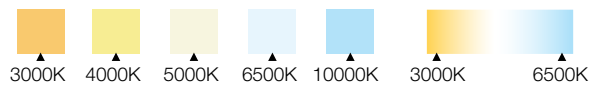

R or G or B



Specifications

Electrical	
Input Voltage	12V / 24V DC Class 2
Power Consumption	Standard : 2.2 w/ft. High - Lumn : 3 w/ft.
Brightness	2,000 Lux to 10,000 Lux
Color Temperature	White LED / Tunable White R or G or B / RGB / RGBW / Digital LED
CRI	90+

Physical	
Max Length	10 ft. (3m)
Weight/m	140g
Dimension (WxH)	29/32" (23mm) x 5/16" (8mm)
Diffuser	Clear / Frosted
Environment	-30°C (-22°F) ~ +40°C (+104°F)
Operating Temperature	Dry location only (Indoor)
Warranty	3 Years